

## Quick Start Guide

### Wi-Fi Programmable Thermostat

RTH6500WF Wi-Fi Series

Search for local rebates: [HoneywellHome.com/Rebates](http://HoneywellHome.com/Rebates)

## Welcome

Getting set up and ready is simple.

- 1 Install your thermostat.
- 2 Connect your home Wi-Fi network.
- 3 Register online for remote access.

### Before you begin

View the installation video at [honeywellhome.com/support](http://honeywellhome.com/support)

- Gather
- Small screw driver
  - Thermostat ID card
  - Your home Wi-Fi network password

# 1 Install your thermostat

## 1.1 Switch OFF power to your heating/cooling system

- 1.1a **Important!** To protect your equipment, switch OFF the power to your heating/cooling system at the breaker box or the system switch.
- 1.1b Confirm power is OFF. Try to turn on heating/cooling equipment by changing temperature on your old thermostat. Your power is OFF if your system does not turn ON.

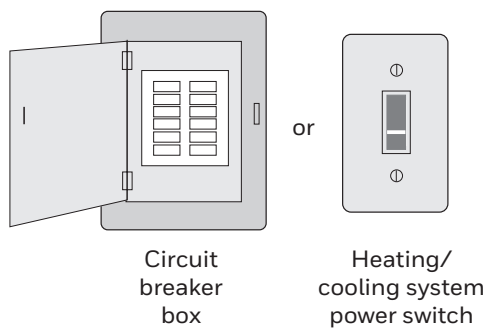

This thermostat works with common 24 volt systems such as forced air, hydronic, heat pump, oil, gas, and electric. It will not work with millivolt systems, such as a gas fireplace, or with 120/240 volt systems such as baseboard electric heat.

## 1.2 Remove old thermostat faceplate and leave wires connected

- 1.2a Take a picture of the wire connections for later reference.
- 1.2b If no wire is connected to a terminal labeled C or no C terminal exists on the old thermostat, view the Alternate Wiring videos at [honeywellhome.com/wifi-thermostat](http://honeywellhome.com/wifi-thermostat)

If you have an older thermostat with a sealed mercury tube, see warning page for proper disposal instructions.

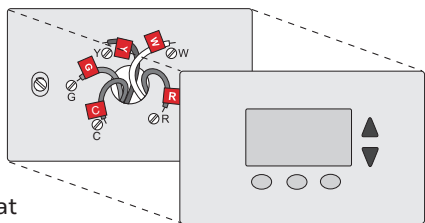

**Important!** C wire is required and is the primary power source for your thermostat. Without a C wire, your thermostat will not power up.

## 1.3 Label wires

**Do not label by wire color.** Use the supplied sticky tags to label each wire as you disconnect it. Label wires according to old thermostat terminal designations, not by wire color.

**Note:** If no tag matches a terminal designation, write the appropriate letter on a blank sticky tag.

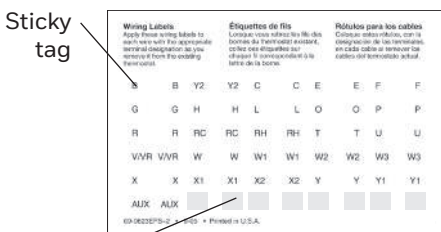

## 1.4 Remove wallplate

Remove the old wallplate from the wall after all wires are labeled and disconnected.

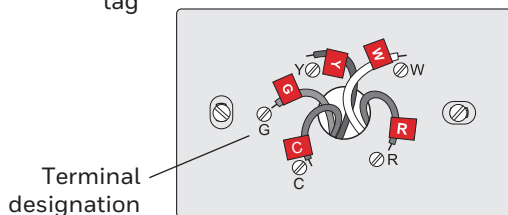

## 1.5 Separate Wi-Fi thermostat and its wallplate

On your new thermostat, grasp the finger holds on the top and bottom of the wallplate with one hand and the thermostat (front) with the other hand. Pull pieces apart.

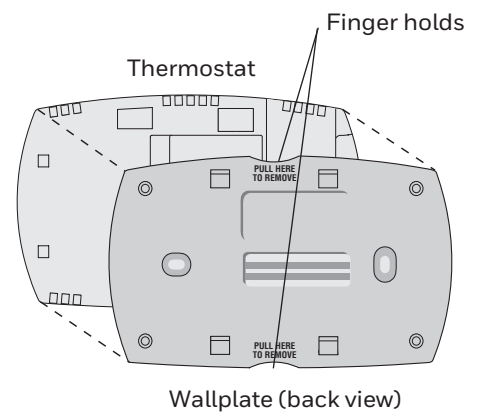

## 1.6 Mount wallplate for Wi-Fi thermostat

Mount your new wallplate using screws and anchors included with the thermostat.

- If necessary:
- Drill 3/16-in holes for drywall
  - Drill 7/32-in holes for plaster

**Note:** You may be able to use your existing wall anchors. Hold the wallplate up to the existing anchors to check for alignment.

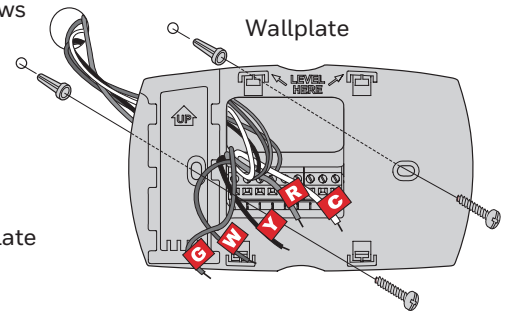

## 1.7 Connect wires

1.7a Starting with the C Wire, match the sticky tag on the wire to the terminal labels.

**Important!** C wire is required and is the primary power source. Without a C wire, your thermostat will not power up.

View the Alternate Wiring videos at [honeywellhome.com/wifi-thermostat](http://honeywellhome.com/wifi-thermostat)

- 1.7b Loosen screw, insert wire on inside edge of terminal, then tighten screw.
- 1.7c Verify wire is firmly secured by gently pulling on wire.
- 1.7d Repeat steps 1.7a–1.7c for all other wires.
- 1.7e Push any excess wire back into the wall opening after all wires are installed.

Labels don't match or have heat pump system? See User Guide.

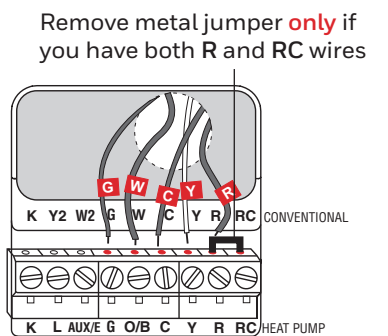

**Note:** The wiring for your application might be different from the wiring shown above.

## 1.8 Install quick reference card

Fold quick reference card along score lines, and slide it into the slot on the back of the thermostat.

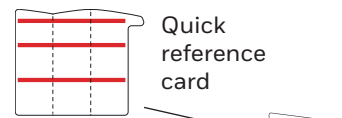

## 1.9 Attach thermostat to wallplate

Align the thermostat onto wallplate and snap into place.

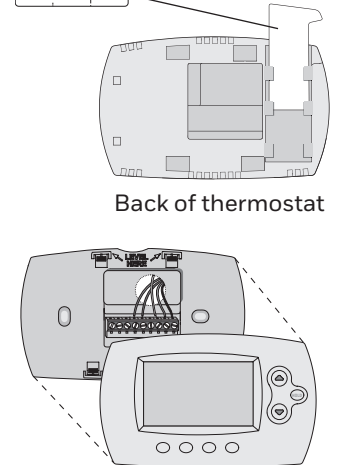

## 1.10 Switch heating/cooling system ON

1.10a Verify that the C wire is connected at the thermostat and at the heating/cooling system.

1.10b Make sure the heating/cooling system door is firmly secured.

1.10c Switch power back ON for your heating/cooling system at the breaker box or its power switch.

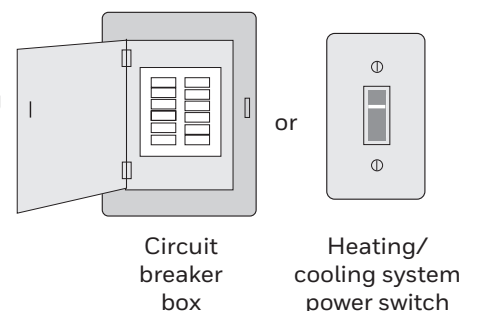

## 1.11 Set date and time

1.11a Press or to set clock.

1.11b Press **Set Day**.

1.11c Press or to select the day of week.

1.11d Press **Done** to save.

(Press and hold a button to quickly change a setting.)

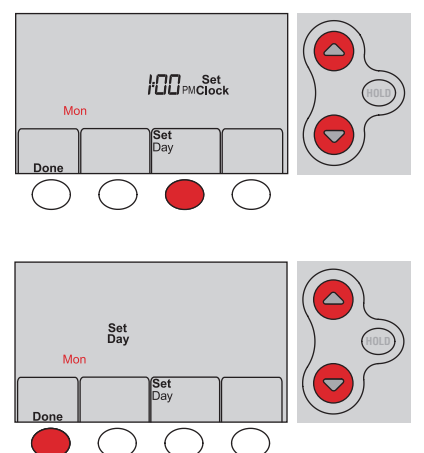

Apple, iPhone, iPad, iPod touch and iTunes are trademarks of Apple Inc. All other trademarks are the property of their respective owners.



## 1.1.2 Determine your heating/cooling system type

**Important!** Heating/cooling system type must be set so that your thermostat operates properly and does not damage your system.

1.12a If you have a traditional system (natural gas forced air with A/C), your thermostat is set up by default to control this system.

Go to **Step ②**.

1.12b If your system is:

- Multistage equipment
- Any type of heat pump
- Hydronic
- Other

You **MUST** change the system type by setting system function 1. See "Setting functions and options" in the *User Guide*.

**?** Not sure of your heating/cooling system type? Refer to FAQ on [honeywellhome.com/support](http://honeywellhome.com/support)

## 1.1.3 Test your thermostat

Congratulations! Your thermostat is operational.

1.13a Press the **System** button to change to heating or cooling and begin operation.

**?** Heating/cooling system not turning on? Refer to User Guide or FAQ at [honeywellhome.com/support](http://honeywellhome.com/support)

1.13b For remote access to your thermostat, continue to **Step ②**.

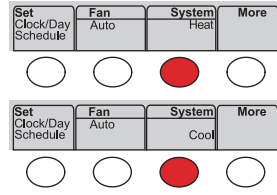

# 2 Connect to your Wi-Fi network

## 2.1 Connect to your thermostat

2.1a Connect your wireless device to your home network. Any of these device types will work:

- Tablet (recommended)
- Laptop (recommended)
- Smartphone

**?** View the Wi-Fi Enrollment video at [honeywellhome.com/wifi-thermostat](http://honeywellhome.com/wifi-thermostat)

**?** **Getting Help**

**If you get stuck...** At any point in this process, restart the thermostat by removing the thermostat from the wallplate, wait for 10 seconds, and snap it back into place. Return to 2.1.

**Need more help?** Find additional information in the *User Guide*.

2.1b Make sure the thermostat displays **Wi-Fi Setup**.

2.1c On the wireless device (laptop, tablet, smartphone), view the list of available Wi-Fi networks.

2.1d Connect to the network called **NewThermostat\_123456** (the number will vary).

**Note:** If you are asked to specify a home, public, or office network, select **Home Network**.

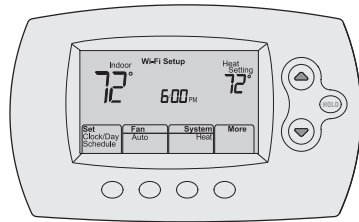

## 2.2 Join your home network

2.2a Open your web browser to access the Thermostat Wi-Fi Setup page. The browser should automatically direct you to the correct page; if it does not, go to <http://192.168.1.1>

2.2b Find the name of your home network on this page and select it.

**Note:** Some routers have enhanced features such as guest networks; use your home network.

2.2c Complete the instructions for joining your Wi-Fi network and click on the Connect button. (Depending on your network setup, you may see an instruction such as Enter Password for your home network.)

**Note:** If you did not correctly connect to the thermostat, you may see your home router page. If so, return to Step 2.1.

Thermostat Wi-Fi-Setup page



## 2.3 Make sure your thermostat is connected

While the connection is in process, your thermostat will flash **Wait** for up to 3 minutes. When the connection is complete, the display will show **Wi-Fi Setup Connection Success**. The Wi-Fi signal strength will appear in the top-right corner.

After about 60 seconds, the home screen will appear and **Register at Total Connect** will flash until **Step ③** (registration) is complete.

**Note:** If the thermostat displays **Connection Failure** or continues to display **Wi-Fi Setup**, confirm you correctly entered your home network password in step 2.2c. If correct, refer to the FAQ at [honeywellhome.com/support](http://honeywellhome.com/support)

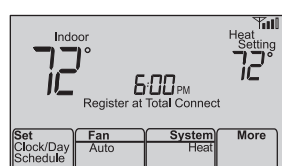
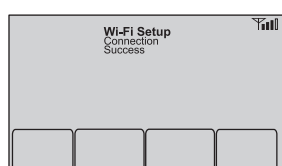

# 3 Register online for remote access

To view and set your Wi-Fi thermostat remotely, you must have a Total Connect Comfort account. Follow the instructions below.

**?** View the Wi-Fi Thermostat Registration video at [honeywellhome.com/wifi-thermostat](http://honeywellhome.com/wifi-thermostat)

## 3.1 Open the Total Connect Comfort web site

Go to [www.mytotalconnectcomfort.com](http://www.mytotalconnectcomfort.com)



## 3.2 Login or create an account

If you have an account,

click **Login**

– or –

click **Create An Account**.

3.2a Follow the instructions on the screen.

3.2b **Check your email** for a response from My Total Connect Comfort. This may take several minutes.

**Note:** If you do not receive a response, check your junk mailbox or use an alternate e-mail address.

3.2c **Follow activation instructions** in the email.

3.2d Log in.



## 3.3 Register your Wi-Fi thermostat

After you are logged in to your Total Connect Comfort account, register your thermostat.

3.3a Follow the instructions on the screen. After adding your thermostat location you must enter your thermostat's unique identifiers:

- MAC ID
- MAC CRC

**Note:** These IDs are listed on the Thermostat ID Card included in the thermostat package. The IDs are not case sensitive.

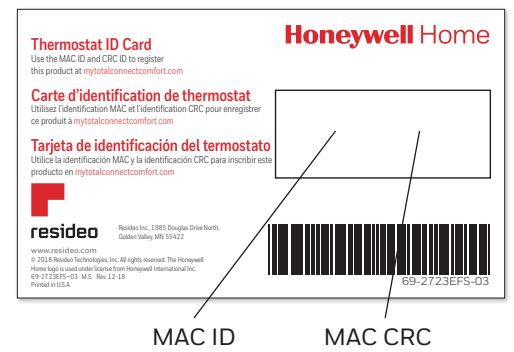

3.3b Notice that when the thermostat is successfully registered, the Total Connect Comfort registration screen will display a **SUCCESS** message.

In the thermostat display, you will see **Setup Complete** for about 90 seconds.

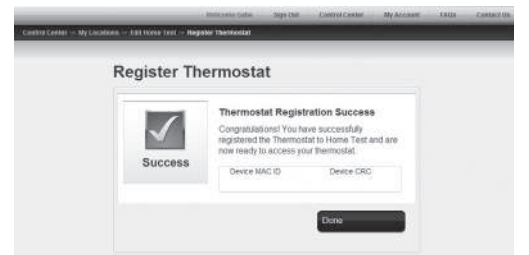

3.3c Also notice that your thermostat displays its signal strength.

Congratulations! You're done. You can now control your thermostat from anywhere through your tablet, laptop, or smartphone.

**72°** Total Connect Comfort free app is available for Apple® iPhone®, iPad® and iPod touch® devices at iTunes® or at Google Play® for all Android™ devices.

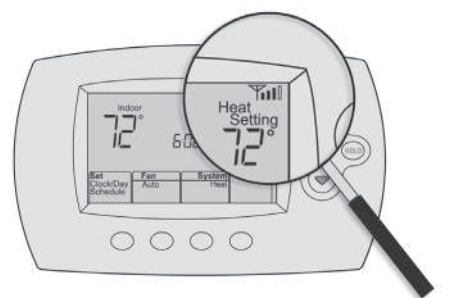

**!** **MERCURY NOTICE:** Do not place your old thermostat in the trash if it contains mercury in a sealed tube. Contact the Thermostat Recycling Corporation at [www.thermostat-recycle.org](http://www.thermostat-recycle.org) or 1-800-238-8192 for information on how and where to properly and safely dispose of your old thermostat.

**!** **NOTICE:** To avoid possible compressor damage, do not run air conditioner if the outside temperature drops below 50°F (10°C).

**Need more help?** Visit [honeywellhome.com/wifi-thermostat](http://honeywellhome.com/wifi-thermostat) or call 1-855-733-5465 for assistance before returning the thermostat to the store.