

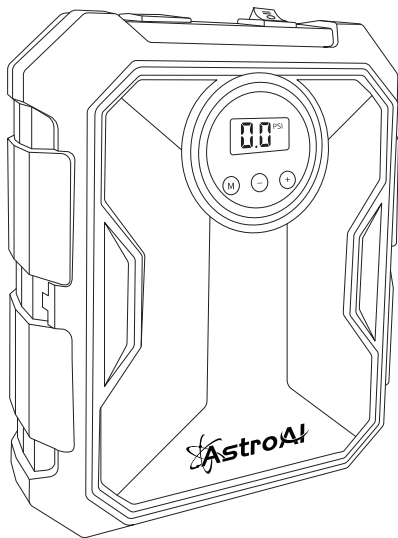

CAR AIR PUMP 100 PSI Portable Air Compressor User Manual



CZK-3674

- V1.1 -

Thank you for purchasing the 100PSI Portable Air Compressor from AstroAI. This product is a programmable Air Compressor Pump with a quality LCD screen that is designed to be used to monitor air pressure while inflating. Once the pre-set air pressure is reached, the Air Compressor will automatically shut off. The smart design of the air compressor supports the storage of hose and cigarette lighter within the product itself . For optimal performance and safety, please read and follow all of the instructions below before operating the device. Please keep this manual for future reference. We hope you enjoy your new Air Compressor!

Thank you again for choosing AstroAI, if you have any questions or concerns regarding your product, please contact us at support@astroai.com.

WARNING //

- Please read the instructions carefully before use. Incorrect usage may damage the product.
- Check the preset pressure value before use. The preset pressure value should match the object to be inflated.
- PSI, KPA, BAR, KG/CM² are pressure units not of pressure levels.
- Please do not use this air compressor in the rain or where there are any liquids.
- Keep out of reach of children, if there are children nearby, please make sure they are properly supervised.
- Keep the air compressor away from fire, corrosive gases, liquids, and strong magnetic fields.
- Do not aim the nozzle at people or any part of a human body.
- Contains small accessories which are a choking hazard for children.
- Risk of electric shock, do not use the air compressor if it is damaged or if wires are exposed.
- Do not use it on a 24V car power. Connect the air compressor to a 12V DC, 15A cigarette lighter; Use an AC to DC power converter if you want to use AC power.
- Avoid extended and continuous use. The optimum time for continuous use is 10 minutes.
- After extended use, let the air compressor rest for 10 minutes before using it again.
- Do not store the air compressor in high-temperatures or in a humid environment.
- When not in use, disconnect the air compressor from all power sources.
- For use with cars, small trucks and SUVs, motorcycles, and bicycles. The air compressor is not intended for use with high pressure or large volume applications.
- During use, do not touch any parts of the air compressor apart from the switch. The air compressor gets hot during use and stays hot for some time after.

- Do not over-inflate tires. Excessive pressure might cause injury.
- Do not drag the air compressor by pulling the power cord or the air hose.
- Do not use chemical substances to clean the air compressor. Only use mild soap and a cloth dipped in hot water to clean the plastic parts.

DIAGRAM

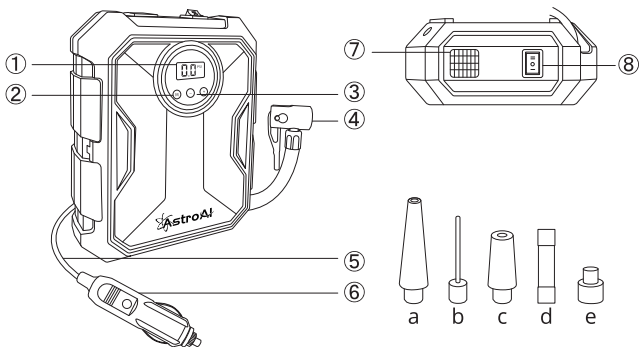

- | | | |
|--------------------------------|-----|-----------------------|
| ① Screen | a/c | 1.2x Air Nozzle Cones |
| ② Unit Button | b | Needle Valve Adapter |
| ③ ' + ' & ' - ' adjust buttons | d | Replacement Fuse |
| ④ Quick Connector | e | Valve Extender |
| ⑤ Power cord | | |
| ⑥ 12V Cigarette Lighter Plug | | |
| ⑦ LED light | | |
| ⑧ Switch | | |

OPERATION INSTRUCTIONS

- Ensure that your car engine is running before you use it.
- Take out the cigarette lighter and extension cord from the groove, insert the cigarette lighter firmly into your car's 12V outlet.

- Press the 'M' button to switch units (4 options: PSI, BAR, KPA, KG / CM²).

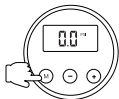

- Use the ' + ' and ' - ' buttons to set the desired pressure.



- Remove the valve cap from the valve stem of the tire, connect air nozzle to the valve stem. (Tips: for better sealing, when using the quick connector, align the valve stem, firmly press in, and flip the small lever. If the illumination function is needed, please press the switch to ' = ' side to turn on the LED light.)

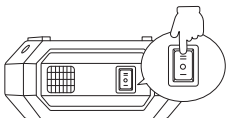

- Press the switch to ' - 'side, the LED light will be lighting and the air compressor will be working.

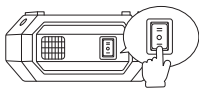

- The air compressor automatically shuts off when the pre-set pressure value is reached. The switch will not switch back to the original position automatically, they need to be pressed to ' o ' position manually for next usage.

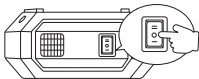

- After usage, unplug the cigarette lighter which is inserted in the car's 12V outlet. When the cigarette lighter and extension cord cool down, put them back into the groove at the back of the air compressor, for better storage.

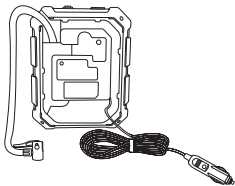

TROUBLESHOOTING ///

I . AIR COMPRESSOR WILL NOT INFLATE

- Ensure the in-line fuse is securely inserted correctly; replace fuse if necessary.
- Check vehicle cigarette lighter fuse, it should be rated at 15A or higher.
- Ensure there is a strong connection with the power cord and 12V socket.
- Preset tire pressure is lower than current tire pressure, increase the preset tire pressure to the manufacturer's recommended level.

II .AIR COMPRESSOR IS OPERATING ABNORMALLY

- The inflation nozzle is not connected properly to the tire's valve stem.
- The 12V socket is not connected securely.

III .AIR LEAKING THROUGH HOSE

- The connection between the air nozzle and the tire valve is not connected securely.

IV .SLOW INFLATION

- The inflation nozzle is not connected properly to the tire's valve stem.
- Excessive use will slow the inflation rate of the air compressor. Let cool for 10 minutes.

SPECIFICATIONS //

Rated voltage	DC 12V
Maximum Power	100 W
Maximum Inflating Speed	25 L / Min
Maximum Working Pressure	100 PSI
Display Units	KPA, PSI, BAR, KG / CM ²
Continuous Operating Time	10 Minutes Maximum
Power Cable Length	9.84 ft (3 m)
Dimensions	5.9×2.55×7.55 in /15×6.5×19.2 cm

PRODUCT HIGHLIGHTS //

- Automatic Shut off: The air compressor automatically shuts off when the pre-set pressure value is reached.
- LCD Digital Display: Provides accurate measurements. It is easy to operate, read and understand.
- The air compressor has a 9.84 ft (3 m) power cord allowing it to reach all the tires of your car.
- Portable design: easy to carry and store in a car.
- Power cut memory function will automatically record your last set.
- LED lighting.
- Easy to store: power cord and hose can be stored in the groove at the back of air compressor.

PACKAGE CONTENTS //

- 1 x AstroAI 12V Air Compressor
- 1 x User Manual
- 1 x Inflation Needle
- 1 x Tapered Adapter
- 1 x Valve Extender
- 1 x Replacement Fuse

1 YEAR WARRANTY LIMITED WARRANTY FROM ASTROAI //

Each AstroAI Portable Air Compressor will be free from defects in material and workmanship. This warranty does not cover damage from neglect, misuse, contamination, alteration, accident, or abnormal conditions of operation or handling. This warranty covers the original purchaser only and is not transferable.

Questions or Concerns? We're happy to help!

support@astroai.com.



Web:www.astroai.com

■ E-mail:support@astroai.com
